

Owner's Manual

Owner's Manual for:
Remington Model SPR 310 and
SPR 320 Over/Under Shotguns

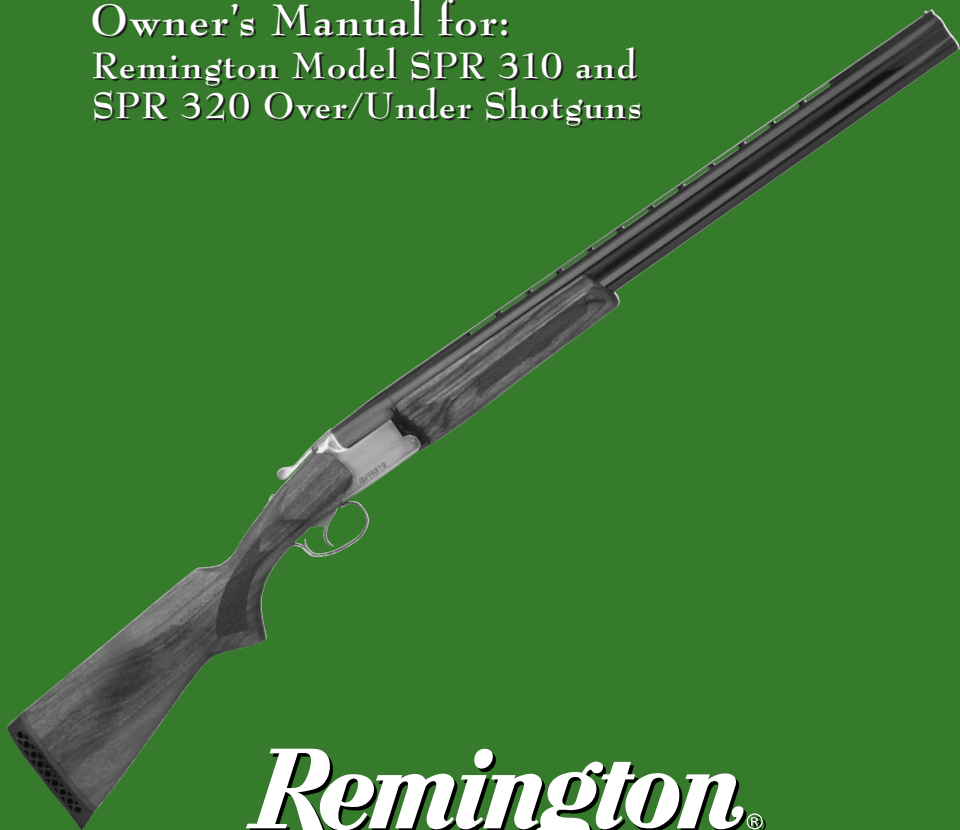

Remington®

IMPORTANT!

READ ALL WARNINGS AND
INSTRUCTIONS IN THIS
MANUAL BEFORE USING THIS SHOTGUN



PAGE 2THE TEN COMMANDMENTS OF FIREARM SAFETY

PAGE 7IMPORTANT PARTS OF THE FIREARM

PAGE 11.....ASSEMBLY INSTRUCTIONS

PAGE 13.....LOADING AND UNLOADING

PAGE 16FIRING

PAGE 17DISASSEMBLY INSTRUCTIONS

Safety is Critical to Performance.

A superbly crafted gun is only as good as the hands that hold it. You can never be too careful. Shooting accidents are often caused by careless oversights such as failing to control the direction of the muzzle, failing to fully engage the safety, leaving ammunition in the chamber or using improper loads. These oversights can result in the destruction of life, limb or property. There's no calling back a bullet once it's been fired, so it's critical that you know the principles of safe gun handling and storage before you ever take your new Remington firearm out of the box.

The proper use and performance of your firearm depends on correct assembly and maintenance, so it's critical that you familiarize yourself with the information in this instruction book. Even if you're a veteran shooter with a collection of Remington firearms, take the time to read this literature. Not all firearms are the same. That means the first step in safe handling is to learn the features and requirements of your new Remington.

THE TEN COMMANDMENTS OF FIREARM SAFETY

With the privilege of owning a firearm comes the responsibility to use it safely. You must understand and follow the Ten Commandments of Firearms Safety at all times. These time-honored safety rules apply to your ownership and handling of any firearm. They must govern your actions whenever and wherever you are involved with firearms . . . in the field, on the range, or in your home. Commit these Ten Commandments to your memory.

1st COMMANDMENT

Always Keep the Muzzle Pointed in a Safe Direction.

This is the most important gun safety rule. A safe direction is one in which an accidental discharge will not cause injury to yourself or others. Never allow your gun to point at anything you don't intend to shoot. Be especially careful when you're loading or unloading. Treat every gun as if it were loaded. And make it a habit to know where the muzzle is pointed at all times, even when your firearm is unloaded. No one will be injured by an accidental discharge if you keep your firearm pointed in a safe direction. It's as simple as that.

2nd COMMANDMENT

Firearms Should be Unloaded When Not in Use and Secured from Unauthorized Use.

Load your firearm only when you are in the field or on the range and ready to shoot. Unload your firearm as soon as you are finished shooting. Never bring a loaded firearm into your camp, home or vehicle. Unloading means unloading both the chamber and the magazine. Before handling a firearm or passing it on to someone else, visually check the chamber, receiver, and magazine to make sure there is no ammunition anywhere in the firearm. Never assume a firearm is unloaded, and never take someone's word for it - look for yourself. When you are finished shooting and have completely unloaded the firearm, leave its action open.

Whenever you are carrying a loaded firearm in the field, you must unload it before crossing a fence, climbing into a tree stand or blind or in any other situation where you may not be able to fully control the firearm. Never pull or push a loaded firearm toward yourself or another person.

Store your firearms unloaded in a secure place where unauthorized persons cannot gain access to them. Store firearms and ammunition separately. If you use an external security device such as a cable lock or trigger lock, you must still keep the firearm unloaded when locked. Whether you utilize a locked gun safe or external locking device, it is your responsibility to make sure that children and other unauthorized persons cannot gain access to your firearm and ammunition.

3rd COMMANDMENT

Never Rely on Your Firearm's Safety Mechanism to Justify Careless Handling.

If your firearm is equipped with a manual safety mechanism, do not rely on the safety as an excuse for improper or careless handling of the firearm. The safety mechanism is merely a supplement to your proper handling of the firearm. The safety mechanism may be broken or altered. Even if you think you have previously engaged the safety in the "safe" position, it may have been inadvertently disengaged without your knowledge while being carried. Never assume that the safety mechanism is engaged in the "safe" position. Your assumption may be wrong or mistaken. Treat your firearms safety mechanism like you would treat any other mechanical device - as something that could break or fail.

Not all safety mechanisms operate in the same manner. Before using any firearm, know and understand precisely how the safety mechanism on that particular firearm operates. Never pull the trigger when the safety mechanism is in the "safe" position, and keep your fingers away from the trigger while loading, unloading, and engaging or disengaging the safety mechanism.

4th COMMANDMENT

Know Your Target and What's Beyond It.

Never fire a shot unless you know exactly where the shot is going and what it will strike. Bullets and shot can travel great distances with deadly velocity. When hunting game, never fire at a sound, a movement or a patch of color - an impulsive shot can have tragic consequences. A fellow hunter in camouflage may be mistaken for game by an impulsive shooter.

In addition to being sure of your target, you must know what lies beyond the target. In other words, make sure of your backstop. Also, beware of ricochets - never shoot at water or a hard surface.

5th COMMANDMENT

Use Proper Ammunition.

Every firearm is designed to use only a specified caliber, gauge or length of ammunition. Use of the wrong ammunition can cause serious personal injury or death. It is your responsibility to make sure the ammunition exactly matches the specifications for your firearm.

Use of improperly reloaded ammunition can also be dangerous. Firearms are designed, manufactured, and proof-tested to specified industry standards. Hand-loaded or reloaded ammunition that deviates, either intentionally or accidentally, from specified loadings can be extremely hazardous. It is strongly recommended, therefore, that you use only factory ammunition from a reputable ammunition manufacturer. If you do reload, you have assumed the risks and responsibilities of an ammunition manufacturer.

6th COMMANDMENT

If Your Firearm Fails to Fire When You Pull the Trigger, Handle With Care.

If a chambered round of ammunition does not fire when you pull the trigger, stop and keep the muzzle pointed in a safe direction. Treat your firearm as if it could still discharge. Keep your face away from the breech. Slowly and carefully open the action, return the safety mechanism to the "safe" position, and unload the cartridge from the chamber. Dispose of the cartridge safely. If your firearm repeatedly fails to fire when you pull the trigger, take your firearm and ammunition to a competent gunsmith or return the firearm to the manufacturer for inspection.

7th COMMANDMENT

Always Wear Eye and Ear Protection.

Wear protective shooting glasses and hearing protection when shooting. Be sure to wear eye protection when disassembling or cleaning a firearm to protect your eyes from springs and other tensioned parts. Continued exposure to shooting noise can permanently damage your hearing.

8th COMMANDMENT

Be Sure the Barrel is Clear of Obstructions Before Shooting.

With your firearm completely unloaded, open the action and make sure there are no obstructions or debris in the barrel. Even a small obstruction such as snow or mud in the barrel can cause the barrel or receiver to burst when the next round is fired. Use a cleaning rod to remove obstructions and residues from the barrel. If the firing noise or recoil seems weak, stop and completely unload your firearm to check for obstructions before firing another shot. NEVER try to shoot out an obstruction by loading and firing another round of ammunition.

9th COMMANDMENT

Never Alter or Modify Your Firearm and Have it Cleaned and Serviced Regularly.

Your firearm has been carefully designed and manufactured to operate according to certain factory specifications. NEVER alter or modify your firearm, especially its trigger or safety mechanism, in any way. Such alterations or modifications can adversely affect the safe operation of your firearm, endangering you and those around you.

As with any mechanical device, the parts of a firearm are subject to wear or breakage. To assure optimum safety and performance, your firearm must be maintained and serviced on a regular basis. Only a competent gunsmith or a Remington Authorized Service Center should service or repair your firearm.

Proper cleaning and lubrication are also important to maintain the safe and proper functioning of your firearm. Follow the cleaning and lubrication instructions set forth in the owner's manual for your firearm. NEVER attempt to clean or lubricate a loaded firearm.

10th COMMANDMENT

Learn How Your Firearm Operates.

Not all firearms are alike. Before you use any firearm for the first time, you must become totally familiar with how that firearm operates. When you receive a new firearm, read and understand the owner's manual before assembling the firearm for the first time. If you acquire a used firearm, request an owner's manual and have the rifle inspected by a competent gunsmith to determine whether it is in good working order. If you do not have an owner's manual, contact the manufacturer to obtain one. If you are selling or trading your firearm to someone else, be sure to transfer the owner's manual to the new owner.

LEAD EXPOSURE WARNING

Discharging firearms in poorly ventilated areas, cleaning firearms or handling ammunition may result in exposure to lead, a substance known to cause birth defects, reproductive harm, cancer and other serious physical injury. Have adequate ventilation at all times. Wash hands thoroughly after exposure.

SHOOT SOBER!

Guns and alcohol or drugs don't mix. Never consume anything that would even mildly impair your judgement or physical coordination while handling a firearm.

WARNING

Failure to follow any of these safety rules may cause personal injury or death to the shooter or bystander and damage to property. Do not use a firearm until you fully understand and practice the Ten Commandments of Firearm Safety. If you have any questions about the safe use of a Remington firearm, write to us at Remington Arms Company, Inc., Consumer Service, P.O. Box 700, Madison, NC 27025-0700, or call us at 1-800-243-9700.

Use the Security Lock Provided with your Shotgun

This shotgun comes with a security lock to assist in protecting against unauthorized use. See **Picture 1**. The shotgun must be unloaded when the security lock is in place on the shotgun. **WARNING:** Using the security lock cannot substitute for securing your firearm and ammunition in separate, locked locations.

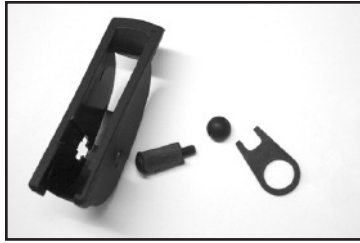

Picture 1

The security lock operates as follows:

1. To open the Trigger Lock put the Key into the notches of the Trigger Lock Nut and un-screw it counter-clockwise (See **Pictures 2 and 3**). Remove the Trigger Lock Screw.

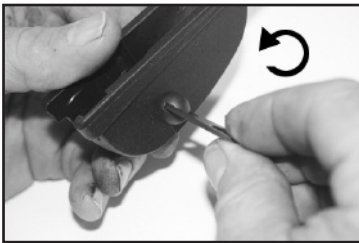

Picture 2

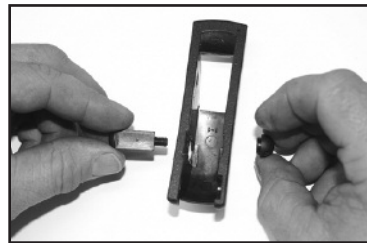

Picture 3

2. To install the Trigger Lock on an over & under break-open shotgun put the Trigger Lock around the trigger guard (See **Picture 4**).



Picture 4

Use the Security Lock Provided with your Shotgun (cont'd)

3. Screw the Trigger Lock Nut on the Trigger Lock Screw (clockwise) and tighten the nut with the key. DO NOT TIGHTEN THE NUT TOO TIGHT OR YOU COULD DAMAGE THE LOCK SCREW (See **Picture 5**).

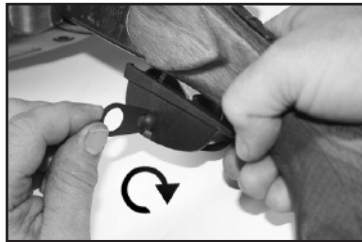

Picture 5

4. To remove the Trigger Lock, unscrew the Trigger Lock nut with the key and detach the Trigger Lock Screw (See **Picture 6**).



Picture 6

WARNING

Always store the key to the security lock: (1) in a separate location away from the shotgun; (2) in a secure location unknown and not accessible to others, especially children. Whether you secure your firearms by using the supplied security lock, a gun lock or a safe or some other mechanism, it is YOUR RESPONSIBILITY to store your firearms in such a manner that children and other unauthorized persons cannot gain access to them.

Important Parts of the Firearm

Congratulations on your choice of a Remington® Model SPR 310 or Model 320 shotgun. With proper care and if used in accordance with the Ten Commandments of Firearm's Safety and this owner's manual, your shotgun should give you many years of dependable use and enjoyment. The following picture depicts the main parts of your shotgun and will aid in understanding the instructions in this Owner's Manual.

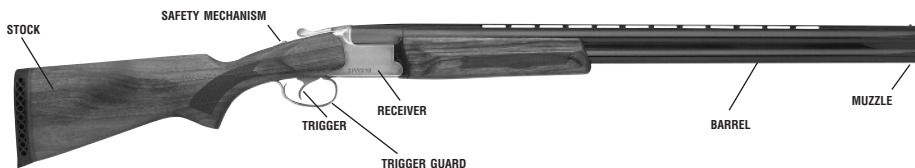

This picture shows the main parts of a Remington Model SPR310 shotgun. The picture will aid in understanding the instructions in this book.

External Control Parts

Trigger Block Safety: The safety mechanism of the shotgun provides protection against accidental and unintentional discharge under normal usage when properly engaged and in good working order. The safety mechanism is not a substitute for the rules of safe gun handling. Do not disengage the safety unless you are ready to fire the shotgun. **MAKE SURE YOU UNDERSTAND HOW THE SAFETY WORKS BEFORE YOU LOAD OR USE THE SHOTGUN.**

The safety mechanism is a tang-style located behind the top lever. (See **Picture 7**). To place the safety in the "on" or "safe" position, pull the button all the way to the rear. When in the "on" or "safe" position, the safety blocks the rearward motion of the trigger(s). To place the safety in the "off" or "fire" position, push the slide all the way to the forward. When in the "off" or "fire" position, a red dot is exposed behind the slide button. You have now disengaged the safety and the shotgun is in the ready-to-fire position, (see **Picture 8**).

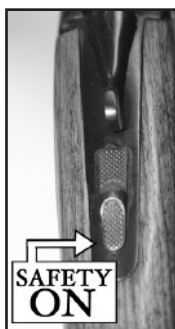

Picture 7

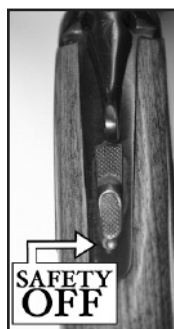

Picture 8



WARNING

Do not touch the trigger(s) while moving the safety. When operating the safety button, make sure you push or pull it to the full extent of its travel in the desired direction, either fully "on" or fully "off." Half-safe or partially safe is UNSAFE.

External Control Parts (cont'd)

Top Lever: The top lever is located just forward of the safety mechanism. (See **Picture 9**). The top lever is used to break open the action to load and/or unload the shotgun, and to assemble and disassemble the shotgun. To break open the action, fully push the top lever to the right. (See **Picture 10**).

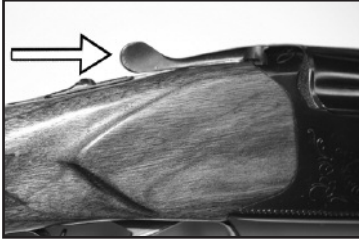

Picture 9

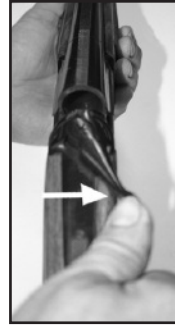

Picture 10

Triggers:

WARNING

Never pull the trigger(s) until you are actually ready to fire. Keep your fingers off the trigger(s) and outside of the trigger guard until you are ready to pull the trigger and fire the shotgun. When opening and closing the action and when engaging or disengaging the safety mechanism, make sure your fingers are outside the trigger guard and away from the trigger(s).

Over/Under shotguns are available in either a double-trigger configuration (Model 320) or a single trigger configuration (Model 310). (See **Picture 11** and **See Picture 12**).

Double-trigger Model 320 shotguns are patterned after classic over & under shotguns with two triggers. The front trigger always fires the bottom barrel. The back trigger always fires the top barrel. Pulling either trigger with the safety in the "off" or "fire" position fires the shotgun.

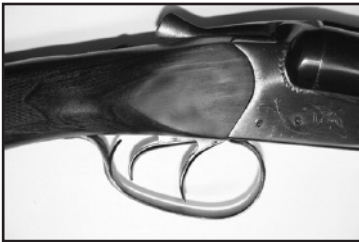

Picture 11



Picture 12

WARNING

Never fire a double-trigger shotgun by using the two fingers because you may inadvertently pull both triggers at the same time resulting in a near simultaneous firing of both barrels. Use your index finger to pull one of the triggers to fire the first shot. After that shot is fired, release the trigger and move your index finger to the other trigger to fire the second shot.

Single-trigger Model 310 shotguns have a single trigger which is used to fire each barrel. Once the trigger is pulled to fire the first barrel, release the trigger. The second barrel is then ready to be fired by pulling the trigger again.

External Control Parts (cont'd)

The Ejectors: Model 310 and 320 shotguns are equipped with ejectors which are preset at the factory for automatic ejection of fired rounds upon opening of the action. However, the ejectors may be adjusted by the user to disable the automatic-ejection feature. When the ejectors are set in the disabled position, fired shells will not be automatically ejected from the barrels when the action is opened.

The ejectors are controlled by set screws located on the curved portion at the front of the receiver. The right side set screw controls the ejection of shells from the bottom barrel. (See **Picture 13**). The left side set screw controls the ejection of shells from the top barrel. (See **Picture 14**).

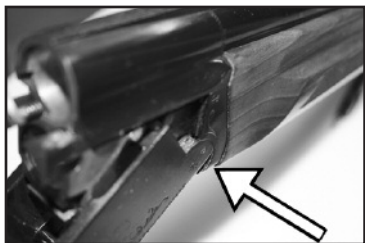

Picture 13

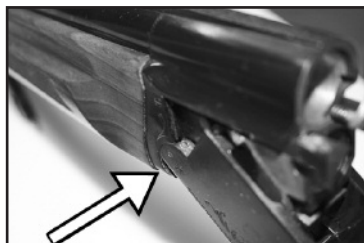

Picture 14

The set screws for the ejectors are preset at the factory for automatic ejection of fired shells when the action is opened. In the automatic setting, the slots in the set screws are oriented in a vertical position running perpendicular to the length of the barrels. See vertical positioning of slots as depicted in (**Picture 15** and **Picture 16**).

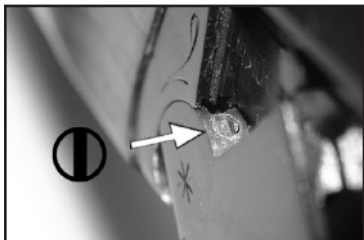

Picture 15

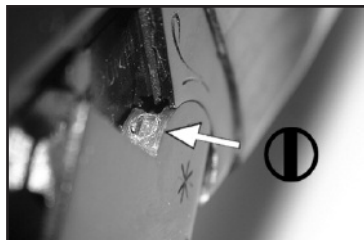

Picture 16

To disable the automatic ejectors, open the action and turn the set screws clockwise $\frac{1}{4}$ of a turn so that the set screw slots are in a horizontal position parallel to the length of the barrels. (See **Picture 17** and **Picture 18**).

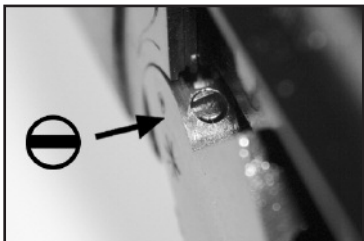

Picture 17

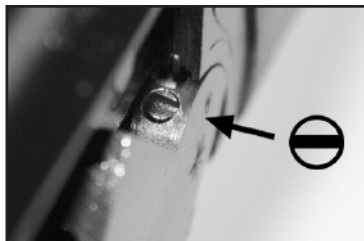

Picture 18

External Control Parts (cont'd)

To return the shotgun to the automatic-ejection mode, simply turn the set screws counterclockwise $\frac{1}{4}$ of a turn to their original position with the set screw slots oriented in a vertical position perpendicular to the length of the barrels. (See **Picture 19** and **Picture 20**).

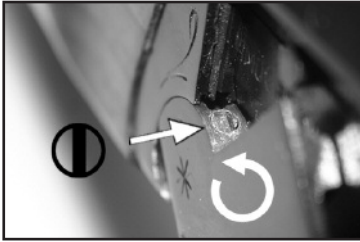

Picture 19

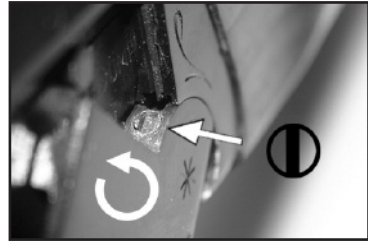

Picture 20

WARNING

Never adjust or disable the ejector set screws when the shotgun is loaded. Adjust the set screws only when the shotgun is completely unloaded.

WARNING

Never remove the ejector set screws from the shotgun. The ejectors are part of the shell case head support system. Shooting the shotgun with the ejectors removed or out of place may cause a shell head rupture causing serious personal injury.

The Barrel Selector (for Model 310 single-trigger shotguns only)

As configured by the factory, the Model 310 single-trigger shotgun is preset to fire the bottom barrel on the first shot and then the top barrel on the second shot. Once the shotgun is loaded, you may manually set the shotgun to fire the top barrel first. To select the top barrel, with the safety engaged in the "on" position, point the muzzle in a safe direction and push the trigger forward from the rear until you feel and hear a click. You have now set the shotgun to fire the top barrel on the first shot and the bottom barrel on the second shot. Note: Once you open the action with the top lever, the shotgun automatically returns to its original configuration of firing the bottom barrel first.

WARNING

When you are pushing the trigger forward to select the top barrel, make sure the safety is "on" and the muzzle is pointed in a safe direction. NEVER use the barrel selector when the safety is in the "off" or "fire" position. Once you have used the trigger to select the top barrel, remove your finger from inside the trigger guard until you are ready to fire.

The Fore End: The fore end is the wooden grip piece which attaches to the barrel assembly and locks the barrel assembly into the receiver. (See **Picture 21**). The fore end has a mechanical latch which is used to lock and unlock the fore end to the barrel assembly. Never attempt to fire your shotgun without having the fore end locked in its proper position on the barrel assembly.

The Barrel Selector (for Model 310 single-trigger shotguns only) (cont'd)



Picture 21

The Serial Number: The shotgun's serial number is located on the top of the receiver underneath the top lever.

WARNING

Never load or fire the shotgun unless the barrel is locked into position on the receiver, and the fore end is locked in to the receiver and barrel.

Instructions For Assembly Of Shotgun

WARNING

Before you begin to assemble the shotgun, you **MUST** (1) look down the barrel from the breech end toward the muzzle end to make sure there is no ammunition in the chambers or obstruction in the barrels, and (2) make sure the safety is in the "safe" position.

Your shotgun was shipped with the barrel assembly (barrel and fore end) detached from the receiver assembly. To assemble the shotgun, follow these instructions:

1. Remove the plastic bags or wrapping covering the parts. Then remove the fore end from the barrel by pulling outward on the mechanical lever in the lower mid-section of the fore end and tipping the fore end out and away from the barrel. (See **Picture 22**).

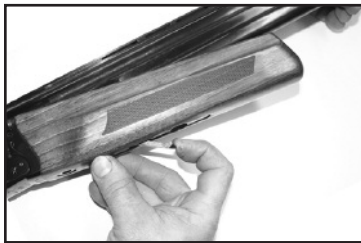

Picture 22

Instructions For Assembly Of Shotgun (cont'd)

- Now push the top lever of the receiver to the right and hold with one hand. Do not force the top lever. (See **Picture 23**).

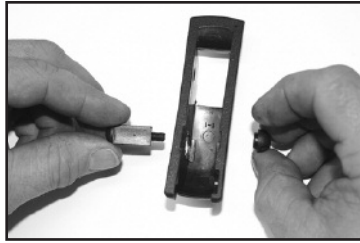

Picture 23

- Holding the barrels with the other hand, engage the lower locking lug located on the lower portion of the barrel with the receiver. The half round cut out on the lower locking lug fits around the round bar in the forward lower portion of the slot in the receiver. With the barrels engaged into the receiver, swing the barrels up into the locked position. The top lever should move back to the center once the barrels are locked into position. Note: The top lever may not move completely to the center on a new shotgun until the gun is broken in. The top lever must move at least three quarters of its full travel distance. (See **Pictures 24, 25 and 26**).



Picture 24



Picture 25



Picture 26

- Now that the barrels have been locked into the receiver, you must reattach the fore end to the barrel. Place the fore end on the front curve of the receiver (the angle between the fore end and barrels should be about 20 degrees). Keeping the contact between fore end and receiver with an upward swing motion, lock the fore end into the barrels. While it may be necessary to push the latch into its final flat position, never force the latch into position. (See **Picture 27**).



Picture 27

Instructions For Assembly Of Shotgun (cont'd)

- Warning:** Never fire the gun unless the barrel is locked into position on the receiver and the fore end is locked into the receiver and barrels.
- Make sure the trigger block safety is engaged after completion of assembly (Red Dot covered) (See **Picture 28**).

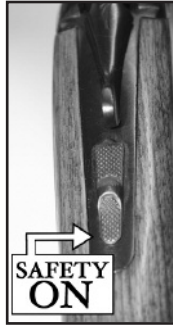

Picture 28

Loading and Unloading Your Shotgun

WARNING

Never load or fire the shotgun unless the barrels is locked into position on the receiver, and the fore end is locked in to the receiver and barrels.

WARNING

Make sure the shotgun is pointed in a safe direction and the trigger block safety is engaged at all times while loading and unloading. NEVER allow your fingers or other objects to contact the trigger (s) while loading or unloading.

WARNING

Do not disengage the trigger block safety until you are ready to fire and have the gun pointed safely downrange

WARNING: DO NOT LOAD SHOTGUN UNTIL YOU ARE READY TO FIRE.

TO LOAD:

- Make sure the ammunition that you are using is the correct size and gauge. The barrel are marked with the gauge and chamber size. Barrels marked 3" (76mm) will use only 2 ³/₄" (70mm) or 3" (76mm) shot shells and must not be used with 3 ¹/₂" (89mm) shells. Barrels marked with 2 ³/₄" (70mm) will use only 2 ³/₄" (70mm) and must not be used with or 3" (76mm) or 3 ¹/₂" (89mm) shells.

Loading and Unloading Your Shotgun (cont'd)

TO LOAD:

2. Visually inspect the chambers and barrels for obstructions by breaking open the shotgun by depressing the locking lever and tipping the barrels down. The chambers and barrels should be free of oil or grease or obstructions. (See **Picture 29**).



Picture 29

3. After inspection, load the correct type of shot shells into the chambers making sure that the shells are flush with the extractor (See **Pictures 30** and **31** on page 17), then close the action by swinging the barrels up until they lock into the receiver and the locking latch should move to its fully locked position (See **Picture 32**). If the locking lever does not move to the fully locked position (See **Picture 33**) break open the action again and check to see if the shot shell is fully seated in the chambers. If the shells are fully seated then re-close the action. If the shot shells are not fully seated check the chambers for blockage and check the shells for deformation and retry closing the action once more. If the shells are the correct type and the chambers are not blocked and the shells are not deformed and the top lever does not move to its fully locked position, unload the gun (follow Unloading Instructions) and have a competent gunsmith look at the gun or return the gun to Remington for inspection. Do not force the shotgun closed.



Picture 30



Picture 31

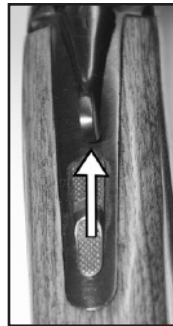

Picture 32

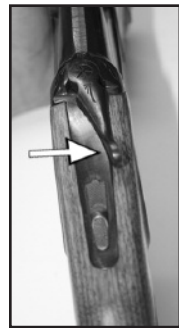

Picture 33

Loading and Unloading Your Shotgun (cont'd)

TO UNLOAD:

1. Break open the shotgun by pushing the top lever of the receiver all the way to the right and tipping the barrels down. (See **Picture 34**).



Picture 34

2. Remove the shell(s) from the chamber(s) by grabbing them by the rim of the shell(s) and pulling them from the chambers. (See **Picture 35**).



Picture 35

3. Visually check the barrels to make sure that they are free from obstructions. (See **Picture 36**).



Picture 36

Firing Your Shotgun



WARNING: NEVER LOAD A CARTRIDGE INTO THE CHAMBER UNTIL YOU ARE READY TO FIRE THE SHOTGUN.



WARNING

Do not disengage the trigger block safety until the shotgun is pointed in a safe direction and you are ready to fire.



WARNING

If a cartridge does not fire and the trigger has been pulled and the trigger block safety is disengaged, Stop! Then do the following: a) Make sure the gun is pointed in a safe direction b) Engage the trigger block safety c) Wait 60 seconds d) Follow the instructions above for unloading the shotgun.



WARNING

If during firing the sound of any cartridge is noticeably softer or louder than the previous cartridge fired, Stop! Then do the following: a) Make sure the gun is pointed in a safe direction b) Engage the trigger block safety c) Follow the instruction above for unloading the shotgun and d) With the shotgun unloaded visually inspect the shotgun for barrel blockage or damage. Then inspect the receiver of the shotgun for damage before continuing.

READ, UNDERSTAND AND FOLLOW ALL WARNINGS AND INSTRUCTIONS IN THIS MANUAL BEFORE FIRING THE SHOTGUN.

TO FIRE THE SHOTGUN:

1. Make sure you are wearing eye and ear protection.
2. Make sure the shotgun is pointed in a safe direction with the trigger block safety engaged. (See **Picture 37**).



Picture 37

3. Keeping your fingers away from the trigger(s), push the trigger block safety to the “off” or “fire” position with the red dot showing. (See **Picture 38**).



Picture 38

Firing Your Shotgun (cont'd)

4. With the butt stock held firmly against your shoulder and the barrel pointed towards your intended target, place your trigger finger on the trigger. The shotgun will fire when you pull or squeeze the trigger with the requisite force. (See **Picture 39**).



Picture 39

5. If you wish to fire a second shot from the other barrel, you must:
 - a) In the case of a Model 310 single-trigger shotgun, release the trigger and then pull or squeeze it again. The second barrel will then fire.
 - b) In the case of a Model 320 double-trigger shotgun, move your finger to the other trigger and pull or squeeze that trigger. The second barrel will then fire.

WARNING

Once you have fired the shotgun, immediately pull the trigger block safety to the "on" or "safe" position. Then follow the unloading instructions above while keeping the muzzle pointed in a safe direction.

Instructions For Disassembly Of The Shotgun

1. Make sure the shotgun is unloaded (**FOLLOW UNLOADING INSTRUCTIONS**) and pointed in a safe direction.
2. Make sure the trigger block safety is engaged in the "on" or "safe" position. (See **Picture 40**).
3. Make sure the barrel assembly is locked into the receiver and the action closed. The top lever should now be in the center position. Remove the fore end from the barrel by pulling out the mechanical lever in the lower center of the fore end and removing the fore end in a downward outward swinging motion. (See **Picture 41**). Never force the fore end off the barrel and receiver.
4. With the barrel and receiver supported with one hand, push the top lever fully to the right and tip the barrel assembly down until it disengages from the receiver. Check the barrels for damage and obstructions after removal. (See **Picture 42**).

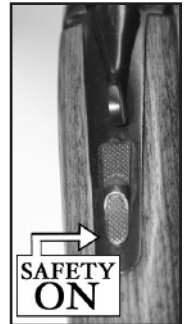

Picture 40



Picture 41



Picture 42

Manufacturer's Warning

This firearm was manufactured to properly perform with the original parts as designed. It is your duty to make sure any parts you buy are correctly installed and that neither replacements nor originals are altered or changed. Your shotgun has many parts that must relate correctly to other parts for safe and accurate operation. Putting a gun together wrong or with modified parts can result in a damaged gun, or personal injury or death to you or others. Always let a qualified gunsmith work on your gun or at least, check any work not performed by a gunsmith. Firearms safety is your primary concern. **THE GUN OWNER MUST ACCEPT FULL RESPONSIBILITY FOR THE CORRECT REASSEMBLY AND FUNCTIONING OF THE FIREARM AFTER ANY DISASSEMBLY OR REPLACEMENT OF PARTS.**

To Clean and Maintain Your Shotgun

- A. Follow procedures for unloading shotgun as described previously.
- B. Follow procedures for disassembly of shotgun as described previously.
- C. Materials needed to clean this shotgun are: a cleaning rod, cotton bore patches, brass bore brush, powder solvent (such as Remington BriteBore™), a small soft brush and good quality gun oil (such as Rem® Oil).

WARNING

Lead or lead compounds are known to the State of California to cause cancer, birth defects, reproductive toxicity, and other serious physical injury. Those who clean firearms should take protective measures to avoid contact or exposure to such chemicals.

- D. Using the bore brush with powder solvent, scrub the interior of the barrel and chamber to remove any powder and lead residue in the bore. Always and lastly, swab the interior of the barrel with a cotton patch with gun oil to coat and protect the bore and chambers from rust and corrosion.
- E. Any powder fouling on the firing wall, barrel, etc. can be easily cleaned with a brush and powder solvent.
- F. All external surfaces should be wiped down with a light coat of rust preventative. Avoid using too much oil as powder, dust or other foreign material may get trapped in the oil. This could lead to congealed deposits which may interfere with the safe and reliable operation of this shotgun.
- G. **USE CAUTION** while using solvents in gun bore cleaning. Prolonged or excess contact with solvents can damage the gun's bluing and finish. Be sure to wipe away all excess solvent and then lubricate with oil.
- H. A gun should be cleaned after firing. In addition, external parts should be wiped with an oiled cloth after handling. A light oil is ordinarily all that is necessary in cleaning if the gun has not been fired or fired very little. If a gun is used frequently, it must be cleaned after each firing and regularly serviced by a professional gunsmith. If the gun has been stored, remove all excess oil and/or grease before firing. Always check to be sure that no cleaning patch or other obstruction remains in the bore or chambers before firing.

DANGER – Ammunition Warning

Firearms may be damaged and serious personal injury or death to the shooter or bystanders may result from any condition which contributes to the generation of excessive pressure or uncontrolled release of gas within the firearm. Such adverse conditions can be caused by bore or chamber obstructions, propellant powder overloads or by defective, incorrect or improperly loaded and assembled cartridge components. Even the strongest firearm can be blown up as a result of excessive pressure. It is extremely dangerous to use a cartridge whose pressure is greater than that developed by cartridges loaded to industry standards.

Ammunition (Cartridges) Notice

We specifically disclaim responsibility for any damage, injury or death occurring in connection with or as the result of the use of the shotgun with faulty, non-standard, remanufactured, hand loaded or reloaded ammunition or with cartridges other than factory cartridges for which the shotgun was originally chambered.

Lubrication Warning

Firing a shotgun with oil, grease or any other material even partially obstructing the bore may result in damage to the shotgun and personal injury to the shooter and those nearby. Do not spray or apply lubricants directly on ammunition. If the powder charge of a cartridge is affected by the lubricant, they may not fully ignite yet the energy from the primer and/or powder may still be sufficient to push the projectile or wad into the bore where it may become lodged. Firing a subsequent cartridge into the obstructed bore will damage the shotgun and may cause personal injury to the shooter and those nearby. Use lubricants properly. You are responsible for the proper care and maintenance of your firearm and ammunition.

PARTS AND SERVICE

To Order Parts

ALL PARTS ARE SUBJECT TO A \$10.00 CHARGE FOR SHIPPING AND HANDLING. Some parts are restricted and may only be installed by returning the shotgun to us. When ordering parts, please state the Model, Gauge, Serial Number, and Finish Color. For parts information, call (321) 639-1432.

Service

To obtain information about returning your shotgun for service or repairs, call (321) 639-1432.

One Year Limited Warranty

This shotgun is warranted to the original retail customer for one year from the date of retail purchase against defects in material and workmanship. All parts and labor or replacement **at our option** are covered. The wood stock is not covered by the one year warranty. The warranty on the wood stock is 60 days and is limited to the original retail customer and extends 60 days from the date of retail purchase and covers only manufactured and material defects.

PARTS AND SERVICE (cont'd)

One Year Limited Warranty

Transportation to and from our repair facilities, government fees, damage caused by failure to perform normal maintenance, sales outside the United States, damage caused by use of high velocity, high pressure, reloaded or other nonstandard ammunition, or by any unauthorized repair, modification, misuse, abuse or alteration of the shotgun is not covered by this Limited Warranty.

Implied Warranty

ANY IMPLIED WARRANTIES, INCLUDING THE IMPLIED WARRANTIES OF MERCHANT ABILITY AND FITNESS FOR A PARTICULAR PURPOSE, ARE LIMITED IN DURATION TO ONE YEAR FROM THE DATE OF ORIGINAL RETAIL PURCHASE. SOME STATES DO NOT ALLOW LIMITATIONS ON HOW LONG AN IMPLIED WARRANTY LASTS, SO THE ABOVE LIMITATION MAY NOT APPLY TO YOU.

To the extent any provision of this warranty is prohibited by federal, state, or municipal law, which cannot be pre-empted, it shall not be applicable. This warranty gives you specific legal rights, and you may also have other rights which may vary from state to state.

To obtain warranty service, send your shotgun with proof of retail purchase, freight prepaid to:

REMINGTON I.S.P.
c/o USSG
402 Richard Road
Rockledge, FL 32955

NOTICE: It is illegal to ship a firearm with ammunition in the firearm or in the same packaging. Firearms and ammunition must be shipped separately. For information about shipping ammunition, call (321) 639-1432.

Your Owner's Manual

Always keep this manual with your shotgun. Make sure you understand all the warnings, operation instructions and safety procedures. When you lend, give or sell the firearm, be sure this manual goes with it. You can get a copy of this manual from Remington upon request.

PARTS LIST

Model SPR310/320 Exploded View

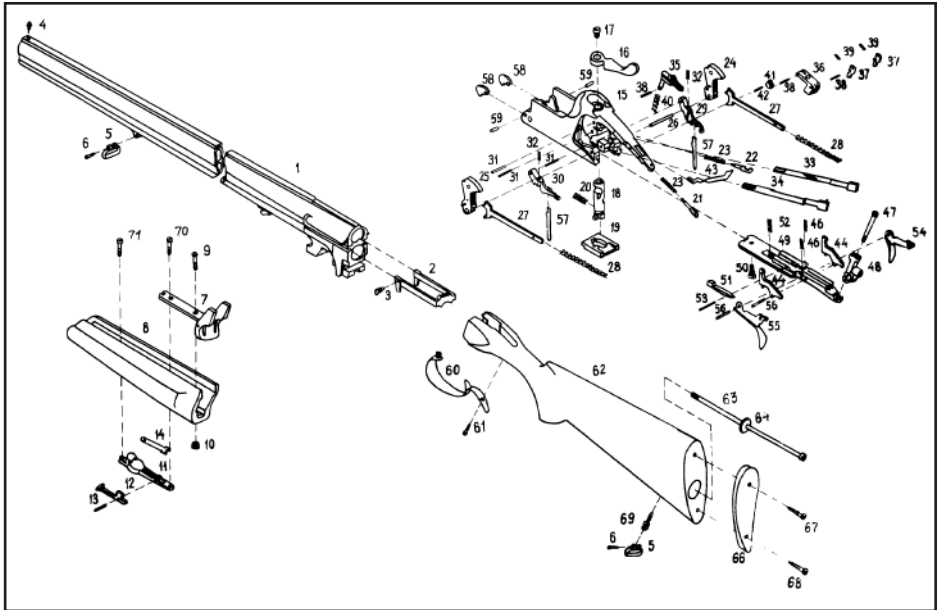

List of Model 310 and 320 Components

- | | | |
|------------------------|-------------------------------|----------------------------|
| 1. barrel assembly | 25. left-hand hammer assembly | 48. bridge |
| 2. ejector | 26. pin | 49. base plate |
| 3. screw | 27. mainspring pivot | 50. screw |
| 4. front sight | 28. mainspring | 51. locking strip retainer |
| 5. swivel ring | 29. right-hand sear | 52. spring |
| 6. pin | 30. left hand sear | 53. pin |
| 7. hinge assembly | 31. pin | 54. right-hand trigger |
| 8. fore grip | 32. spring | 55. left-hander trigger |
| 9. screw | 33. right-hand bolt plunger | 56. pin |
| 10. bush | 34. left-hand bolt plunger | 57. trigger bar |
| 11. catch casing | 35. safety lock button | 58. cock |
| 12. fore grip catch | 36. safety lock base | 59. pin |
| 13. pin | 37. safety lock | 60. trigger guard |
| 14. spring | 38. pin | 61. woodscrew |
| 15. housing | 39. spring | 62. butt |
| 16. locking lever | 40. spring | 63. screw |
| 17. screw | 41. clip | 64. washer |
| 18. locking lever axle | 42. pin | 65. butt plate |
| 19. locking strip | 43. slide | 66. butt plate |
| 20. recoil spring | 44. interceptor | 67. woodscrew |
| 21. top striker | 46. spring assembly | 68. woodscrew |
| 22. bottom striker | | 69. swivel base |
| 23. striker spring | | 70. screw |
| 24. right-hand hammer | | 71. screw |
| | | 72. washer |
| | | 47. screw |

Model 310/320 Ejector Parts

LIST OF COMPONENTS

1. barrel assembly
2. right-hand ejector
3. left-hand ejector
4. ejector spring
5. plunger
6. hinge assembly
7. fore grip
8. ejector right-hand sear
9. ejector left-hand sear
10. ejector sear bolt
11. spring
12. base
13. right-hand bolt plunger
14. left-hand bolt plunger
15. tripping lever
16. tripping lever catch
17. spring

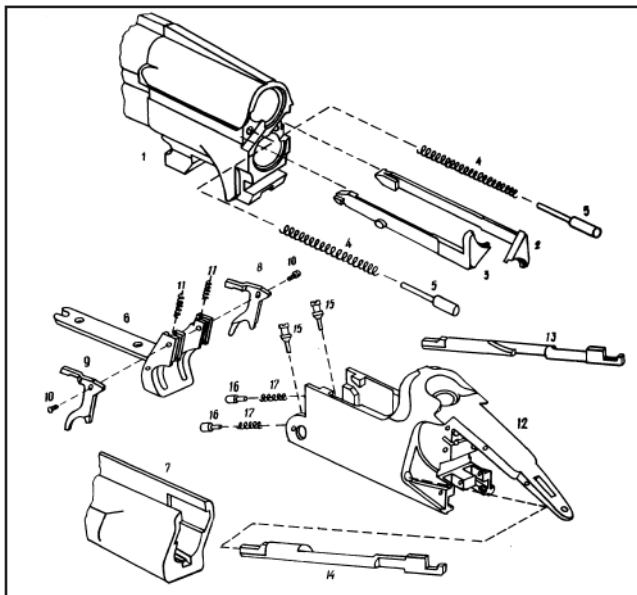

Model 310 Single Trigger Mechanism Parts

LIST OF COMPONENTS

1. carrier
2. locking strip
3. right-hand sear
4. left-hand sear
5. inertia-type tripping lever
6. interceptor
7. base plate
8. trigger
9. selector lever
10. selector lever spring
11. selector lever pin
12. trigger bar
13. tripping lever spring
14. trigger bar spring
15. tripping lever pin
16. trigger bar pin
17. trigger spring
18. change lever spring screw
19. interceptor spring

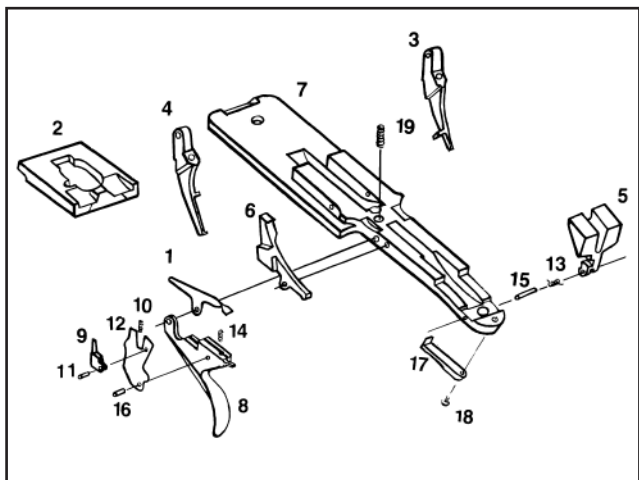

Choke Tubes



WARNING

Never install or remove choke tubes while the firearm is loaded. Only install or remove choke tubes with the firearm unloaded, the action open and the trigger block safely engaged.

Screw in Chokes Symbols/Markings (This is an option – not all Model 310 or 320 shotguns have this feature)

The end of the choke tubes are marked with slashes to identify the choke construction:

- / - Full
- // - Improved Modified
- /// - Modified
- //// - Improved Cylinder
- CI - Cylinder



WARNING

MAKE SURE YOU FULLY TIGHTEN THE CHOKE TUBE.

Shooting with a loose choke tube can cause damage to your shotgun.

Additional Information On Screw Choke Tubes:

- A. Only tighten or loosen choke tubes with flat key wrench supplied with shotgun. Note: wrench (and extra choke tube or tubes if supplied) are under the cardboard in front of the shotgun receiver in the box.
- B. Never shoot the shotgun with a partially installed choke tube.
- C. Model 100 shotguns are available with fixed choke or screw choke barrels. There are two types of screw chokes available: lead shot choke tubes and steel shot choke tubes. When installed, steel shot choke tubes protrude approximately $\frac{3}{4}$ " from the muzzle end of the barrel and the mating lip will be flush with the end of the barrel. When installed, lead shot choke tubes fit flush with or slightly below the muzzle end of the barrel. If you have lead shot choke tubes and intend to shoot steel shot cartridges or slugs, then you must use only the IC or Cylinder tubes. DO NOT fire steel shot or slugs in Modified, Improved Modified or Full lead shot choke tubes. If you have steel shot choke tubes, you may fire steel shot cartridges through any of those choke tubes. DO NOT fire slugs in Modified, Improved Modified or Full lead shot choke tubes or steel shot choke tubes.

Additional Information On Screw Choke Tubes: (cont'd)

- D. Correctly installed choke tubes: Lead shot choke tubes should fit flush or slightly below the muzzle end of the barrel. Steel shot choke tubes will protrude out from the barrel about $\frac{3}{4}$ " and the mating lip will be flush with barrel end.
- E. Before using the shotgun make sure that the choke tubes are installed correctly.
- F. Keep choke tubes lubricated and installed. Never fire the gun without a choke tube installed. Handle choke tubes carefully since the leading edge is very thin.

Notes on Shot Material and Chokes:

- 1. Shells using Bismuth or Tungsten-Matrix shot are subject to the same barrel and choke tube limitations as lead shot. Shells using Tungsten-Iron shot or Hevi-Shot are subject to the same barrel and choke tube limitations as steel shot.
- 2. On fixed choke guns, shells loaded with steel, Tungsten-Iron or Hevi-Shot should be fired only in IC or Cylinder barrels. DO NOT fire steel, Tungsten-Iron or Hevi-Shot shells in fixed barrels with Modified, Improved Modified or Full choke barrels. Lead, Bismuth and Tungsten-Matrix may be fired in all fixed choke barrels.
- 3. On fixed choke guns, slugs may be fired in only IC and Cylinder barrels. DO NOT fire slugs in fixed choke barrels with Modified, Improved Modified or Full chokes.

If you would like to buy extra choke tubes (skeet, trap, extra full, etc.) call (321)-639-1432.



WARNING

Children are attracted to and can operate firearms that can cause severe injuries or death. Prevent child access by always keeping guns locked away and unloaded when not in use. If you keep a loaded firearm where a child obtains and improperly uses it, you may be fined or sent to prison.



ADVERTENCIA

A los niños les atraen las armas de fuego y los pueden hacer funcionar. Ellos pueden causarse lesiones graves y la muerte. Evite que los niños tengan acceso a las armas de fuego guardándolas siempre con llave y descargadas cuando no las esté utilizando. Si usted tiene un arma de fuego cargada en un lugar en que un niño tiene acceso a ella y la usa indebidamente. Le pueden dar una multa o enviarlo a la cárcel.

REMINGTON I.S.P.
c/o USSG
411 Hawk Street
Rockledge, FL 32955

Manufacturer:
Izhevsky Mekhanichesky Zavod
8, Promyshlennaya str.,
426063 Izhevsk, Russia

Remington®

Remington is a trademark registered in the United States Patent and Trademark Office by Remington Arms Company, Inc.